

**INSTALLATION INSTRUCTIONS FOR CONTEMPORARY FACADE KITS
FOR USE WITH GEMINI CD AND DRC3000 FIREPLACES**

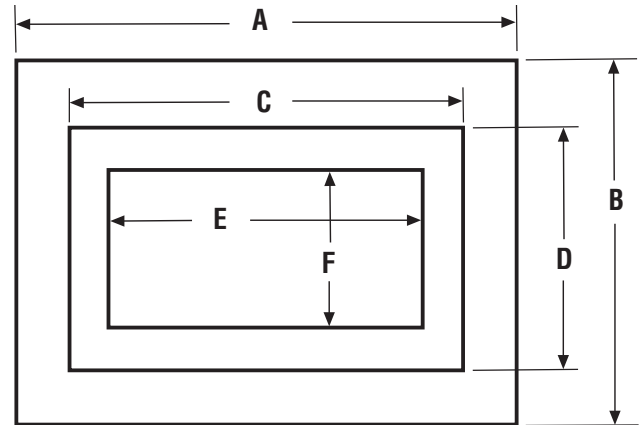
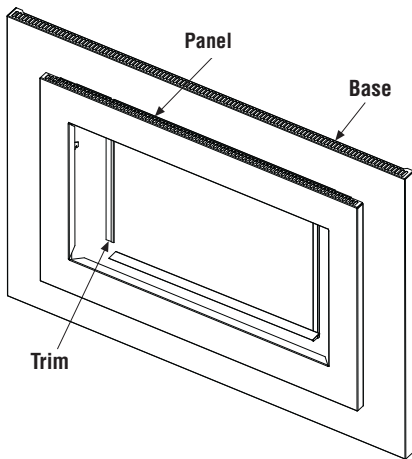

Contemporary Facade Units				
	35" Models		40" Models	
Description	Cat. No.	Model No.	Cat. No.	Model No.
<i>Choose One Base Kit</i>				
Facade Base Black	F2460	FBBK35CD	F2462	FBBK40CD
Facade Base Stainless	F2461	FBSS35CD	F2463	FBSS40CD
<i>And Choose One Panel Kit</i>				
Facade Panel Black *	F2464	FPBK35CD	F2466	FPBK40CD
Facade Panel Stainless *	F2465	FPSS35CD	F2467	FPSS40CD

Table 1

* The panel kits include trim.

GENERAL INFORMATION

The Contemporary Facade Kit is composed of two separate elements (one base kit and one panel kit with trim) that are purchased separately. Refer to **Table 1**.

NOTE: To complete one Facade a selection of one Base and one Panel kit must be made.

The Panel must be installed on a properly positioned Gemini CD or DRC3000 fireplace. Refer to Installation and Operation manual for detailed instructions. Refer to **Table 2** for facade significant dimensions.

Facade Dimensions						
	A	B	C	D	E	F
35" Model	44-1/2 (1130)	32-7/8 (835)	35-1/2 (902)	23-7/8 (606)	29 (737)	16 (406)
40" Models	49-1/2 (1257)	37-7/8 (962)	40-1/2 (1029)	28-7/8 (733)	34 (864)	21 (533)

Table 2

INSTRUCTIONS

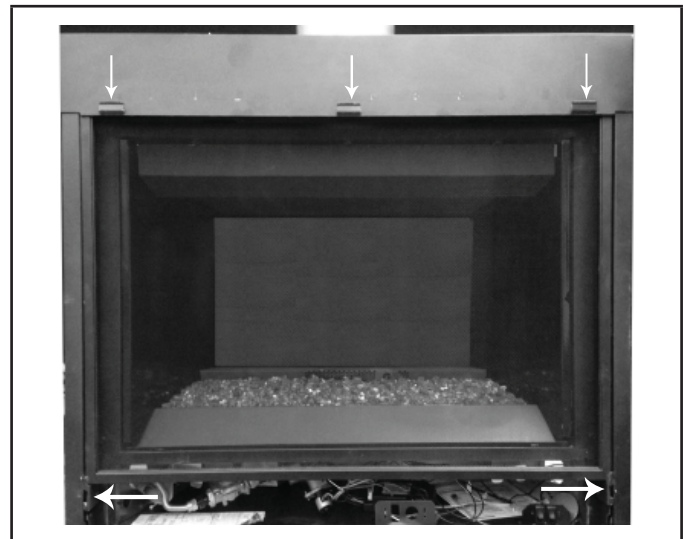
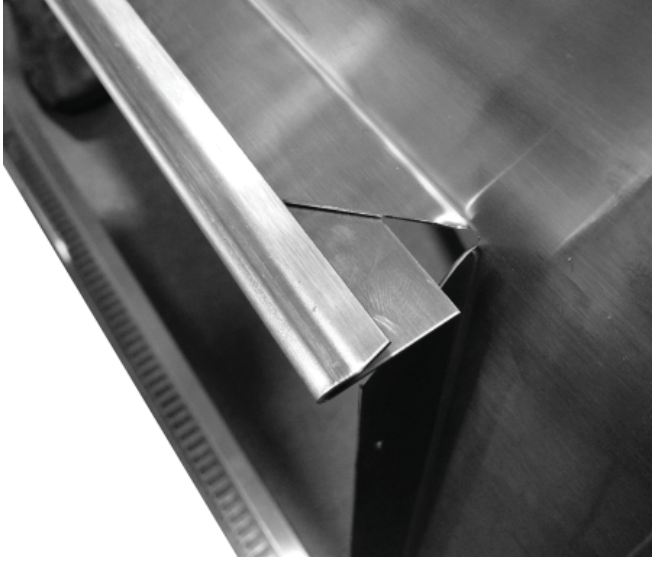
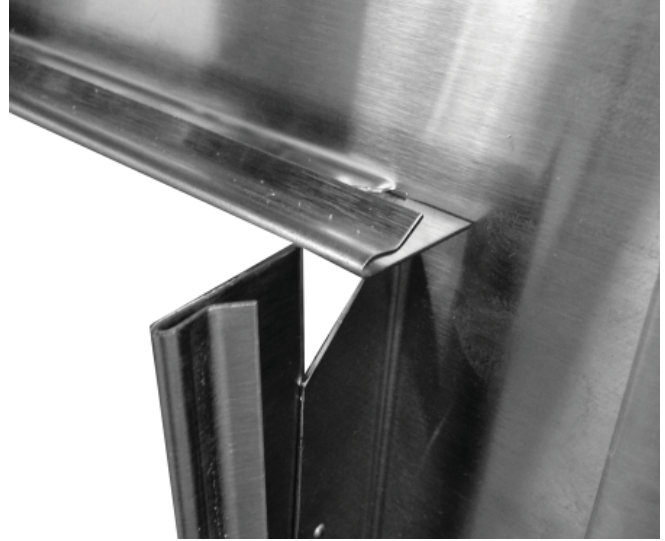

Figure 1

Start by locating the fireplace face brackets indicated by the arrows at the top **Figure 1** and the fireplace face foot slots indicated by the arrows at the bottom of **Figure 1**. Proceed with the steps on **Page 2**.



Step 1. Slide top trim pieces over flange of panel until seated squarely.



Step 2. Slide side trim pieces into place (top will overlap slightly). Repeat Step 1 and Step 2 for bottom and opposite side trim for panel.

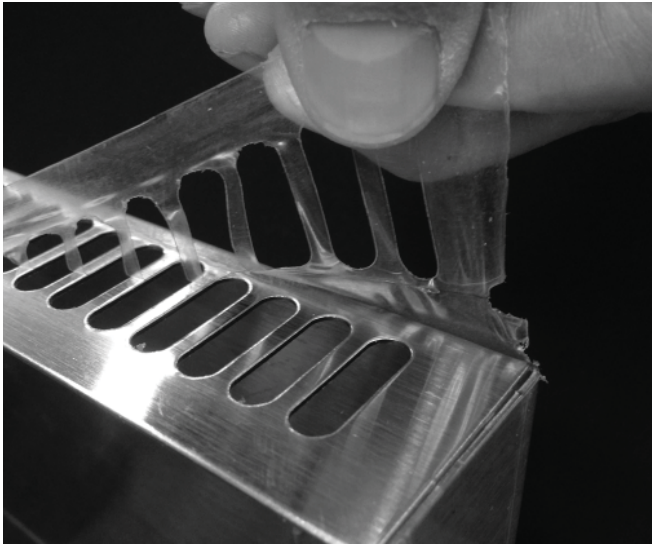

NOTE: Remove protective flim from all stainless components before installation.



Step 3. Plug lead wires into the IPI Switch on right side of facade base.

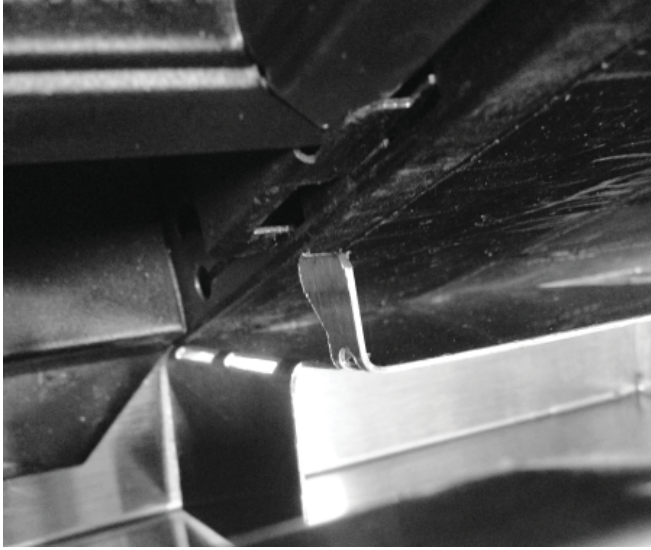

Step 4a. Slide the foot tabs of the facade base into the slots (*see Figure 1*) on both sides near the bottom of the fireplace opening.

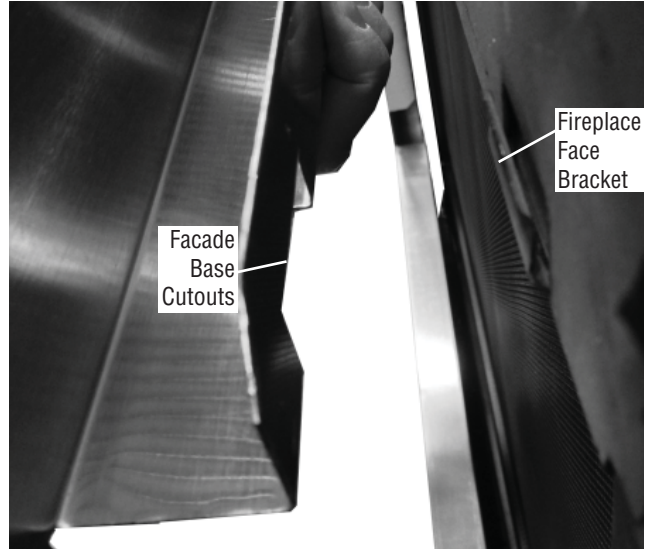

Step 4b. Tilting the facade base up on its foot tabs, secure the top by engaging the three brackets (*see Figure 1*) on the face of the fireplace with the three cut outs on the back top of the facade base.

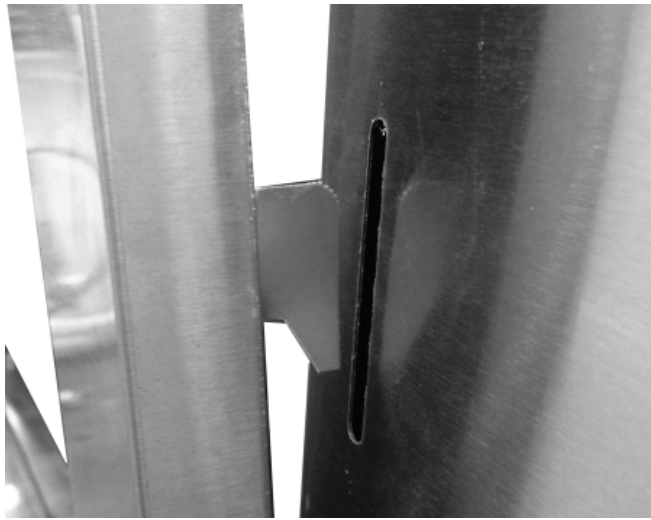

Step 5. Slide the tabs on the back of both sides of the facade panel into the slots on the base.



(Black Base and Stainless Panel shown)

IHP reserves the right to make changes at any time, without notice, in design, materials, specifications, prices and also to discontinue colors, styles and products. Consult your local distributor for fireplace code information.

